

ET-5050RTB-311W

Ultra high luminous efficacy, combined with the flexibility in design due to its slim and miniature size, PLCC LED Series are optimized to be used as lighting for signboard.

Features

- High Luminous Intensity
- Based on Blue/Green : InGaN, Red : AlGaInP technology
- Wide Viewing Angle : 120°
- Excellent Performance and Visibility
- Suitable for all SMT assembly methods
- IR reflow process compatible
- Environmental friendly; RoHS compliance

Typical Applications

- Signal and Symbol Luminaire
- Indoor and Outdoor Displays
- Backlighting (illuminated advertising, general lighting)
- Interior Automotive Lighting

Table of Contents

Product Nomenclature	2
Environmental Compliance	3
LED Package Dimensions and Polarity	4
Absolute Maximum Ratings	5
Luminous Intensity Characteristics	6
Forward Voltage Characteristics	6
JEDEC Information	7
Reliability Items and Failure Measures	8
Color Spectrum and Radiation Pattern.....	9
Optical & Electrical Characteristics	11
Product Soldering Instructions	12
Product Packaging Information	14
Precaution for Use	16
Forward Voltage Rank	18
Luminous Intensity Rank.....	18
Dominant Wavelength Rank	19

Product Nomenclature

The following table describes the available color, package size, and chip quantity.

< Table 1 PLCC 5050 series nomenclature >

E T – 5050 RTB – 3 1 1 W
 X1 X2 X3 X4 X5 X6 X7

X1 LED Item		X2 Package Type		X3 Emitting Color			X4 Chip Quality		X5 Phosphor
Code	Type	Code	Type	Code	Type		Code	Type	
ET	Edison TopLED	3020	3.0*2.0mm	W	Cool White	○	1	1 pcs	
		3528	3.5*2.8mm	X	Warm White	●	3	3 pcs	
		5050	5.4*5.0mm	R	Red	●			
				A	Amber(615nm)	●			
				Y	Yellow(590nm)	●			
				T	True Green	●			
				B	Blue	●			
				RTB	RGB 3 chips	●	●	●	

X6 Die source	X7 Feature
	Code Type
	W White surface
	B Black surface

Environmental Compliance

PLCC 5050 series are compliant to the Restriction of Hazardous Substances Directive or RoHS. The restricted materials including lead, mercury cadmium hexavalent chromium, polybrominated biphenyls (PBB) and polybrominated diphenyl ether (PBDE) are not used in PLCC 5050 series to provide an environmentally friendly product to the customers.

LED Package Dimensions and Polarity

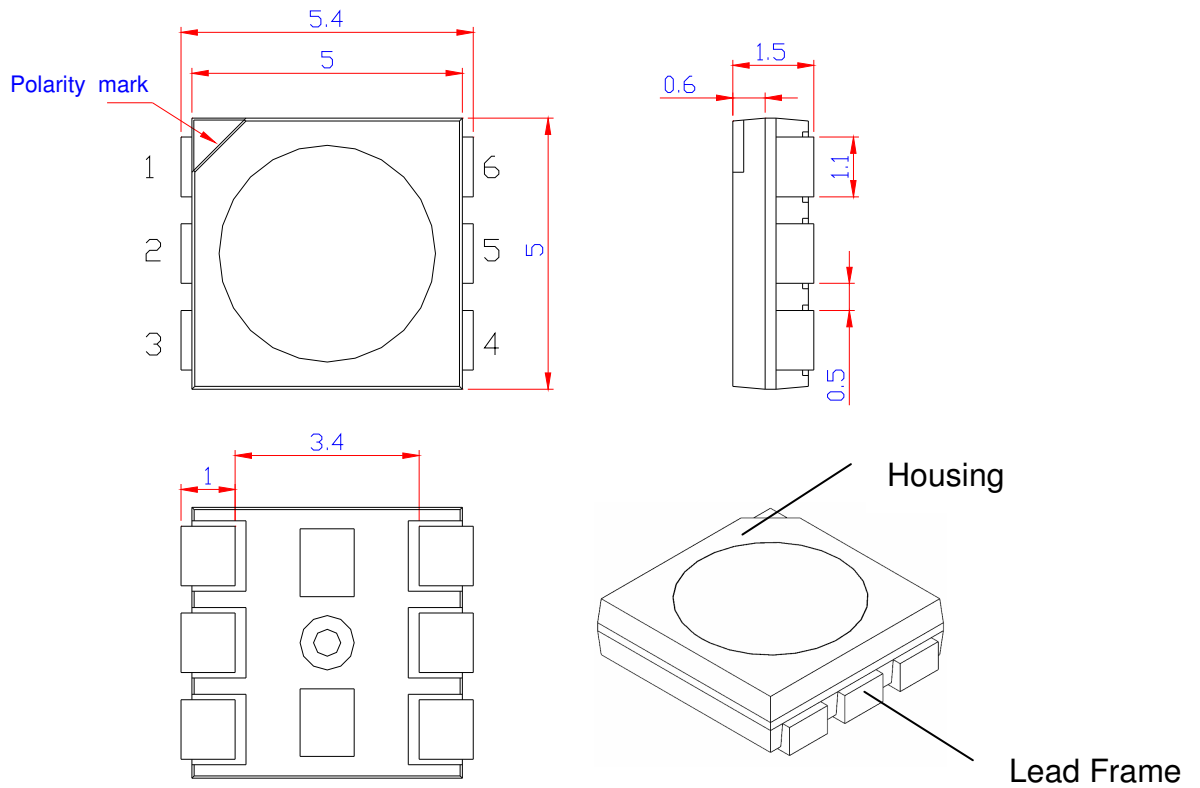

< Figure 1 PLCC 5050 series dimensions >

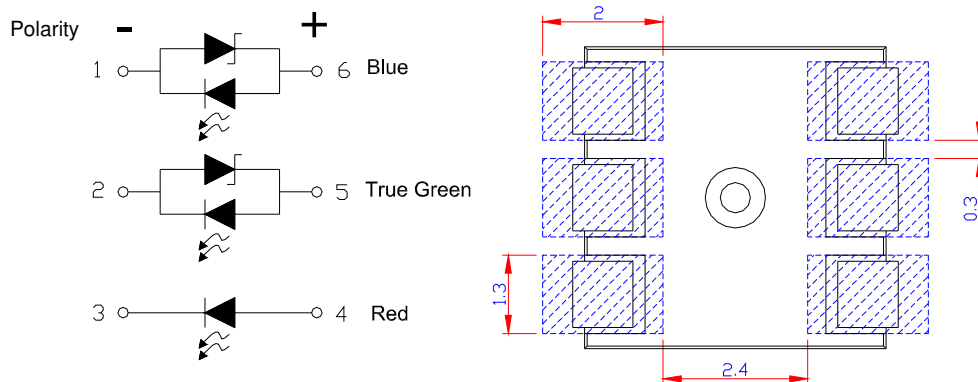

< Figure 2 PLCC 5050 series circuit diagram and recommended soldering pad >

Notes:

1. All dimensions are in mm.
2. Tolerance : ± 0.2 mm

Absolute Maximum Ratings

The following table describes absolute maximum ratings of PLCC 5050 series.

< Table 2. Absolute maximum ratings for PLCC 5050 series >

Parameter	Rating(R)	Rating (T) / (B)	Unit	Symbol
Forward Current	35	30	mA	I_F
Pulse Forward Current ($t_p \leq 100\mu s$, Duty cycle=0.25)	80	100	mA	
Reverse Current(per die)	10	10	μA	I_R
Reverse Voltage	5	5	V	V_R
Forward Voltage	2.8	3.7	V	V_F
Power Dissipation	100	110	mW	
LED Junction Temperature	115		$^{\circ}C$	T_J
Operating Temperature	-30 ~ +85		$^{\circ}C$	
Storage Temperature	-40 ~ +100		$^{\circ}C$	
Soldering Temperature	255~260		$^{\circ}C$	
Manual Soldering at 350 $^{\circ}C$ (Max.)	3		Sec	

Notes:

1. Proper current derating must be observed to maintain junction temperature below the maximum at all time.
2. LEDs are not designed to be driven in reverse bias.
3. t_p : Pulse width time

Luminous Intensity Characteristics

The following table describes luminous intensity of PLCC 5050 series.

< Table 3 Luminous intensity characteristics at $I_F=20\text{mA}/\text{chip}$ and $T_a=25^\circ\text{C}$ for PLCC 5050 series >

Part Name	Color	Luminous intensity(mcd)			Luminous Flux Typ.(lm)
		Min.	Typ.	Max.	
ET-5050RTB-311W	Red	300	500	--	1.5
	True Green	700	1,100	--	3.4
	Blue	175	310-	--	1.0

Note:

- Luminous intensity is measured with an accuracy of $\pm 10\%$.

Forward Voltage Characteristics

The following table describes forward voltage of PLCC 5050 series

< Table 4 Forward voltage characteristics at $I_F=20\text{mA}/\text{chip}$ and $T_a=25^\circ\text{C}$ for PLCC 5050 >

Part Name	Color	V_F			Unit
		Min.	Typ.	Max.	
ET-5050RTB-311W	Red	1.8	--	2.8	V
	True Green	2.8	--	3.7	V
	Blue	2.8	--	3.7	V

Note:

- Forward Voltage is measured with an accuracy of $\pm 0.1\text{V}$

JEDEC Information

JEDEC is used to determine what classification level should be used for initial reliability qualification. Once identified, the LEDs can be properly packaged, stored and handled to avoid subsequent thermal and mechanical damage during the assembly solder attachment and/or repair operation. The present moisture sensitivity standard contains six levels, the lower the level, the longer the devices floor life. PLCC 5050 series are certified at level 2a. This means PLCC 5050 series have a floor life of 4 weeks before PLCC 5050 series need to re-baked.

< Table 5 JEDEC characteristics for PLCC 5050 series >

Level	Floor Life		Soak Requirements			
	Time	Condition	Standard Time (hours)	Condition	Accelerated Environment Time (hours)	Condition
2a	4 weeks	$\leq 30^{\circ}\text{C}$ / 60% RH	696 +5/-0	30°C / 60% RH	120 +1/-0	60°C / 60% RH

Level	Floor Life		Soak Requirements			
	Time	Condition	Standard Time(hours)	Condition	Accelerated Equivalent Time(hours)	Condition
1	Unlimited	$\leq 30^{\circ}\text{C}/85\% \text{ RH}$	168 +5/-0	$85^{\circ}\text{C}/85\% \text{ RH}$		
2	1 year	$\leq 30^{\circ}\text{C}/60\% \text{ RH}$	168 +5/-0	$85^{\circ}\text{C}/60\% \text{ RH}$		
2a	4 weeks	$\leq 30^{\circ}\text{C}/60\% \text{ RH}$	696 ¹ +5/-0	$30^{\circ}\text{C}/60\% \text{ RH}$	120 +1/-0	$60^{\circ}\text{C}/60\% \text{ RH}$
3	168 hours	$\leq 30^{\circ}\text{C}/60\% \text{ RH}$	192 ¹ +5/-0	$30^{\circ}\text{C}/60\% \text{ RH}$	40 +5/-0	$60^{\circ}\text{C}/60\% \text{ RH}$
4	72 hours	$\leq 30^{\circ}\text{C}/60\% \text{ RH}$	96 ¹ +5/-0	$30^{\circ}\text{C}/60\% \text{ RH}$	20 +5/-0	$60^{\circ}\text{C}/60\% \text{ RH}$
5	48 hours	$\leq 30^{\circ}\text{C}/60\% \text{ RH}$	72 ¹ +5/-0	$30^{\circ}\text{C}/60\% \text{ RH}$	15 +5/-0	$60^{\circ}\text{C}/60\% \text{ RH}$
5a	24 hours	$\leq 30^{\circ}\text{C}/60\% \text{ RH}$	48 ¹ +5/-0	$30^{\circ}\text{C}/60\% \text{ RH}$	10 +5/-0	$60^{\circ}\text{C}/60\% \text{ RH}$
6	Time on label (TOL)	$\leq 30^{\circ}\text{C}/60\% \text{ RH}$	TOL	$30^{\circ}\text{C}/60\% \text{ RH}$		

Note:

1. The standard soak time includes a default value of 24 hours for semiconductor manufacturer's exposure time (MET) between bake and bag, and includes maximum time allowed out of the bag at the distributor's facility.

Reliability Items and Failure Measures

Reliability test

The following table describes operating life, mechanical, and environmental tests performed on PLCC 5050 series.

< Table 6 Operating life, mechanical, and environmental characteristics for PLCC 5050 series

>

Reliability Test 1			
Stress Test	Stress Conditions	Stress Duration	Failure Criteria
Temperature and Humidity	60°C / 60%RH	120 hours	No catastrophics
IR Reflow	Peak temp.=255~260°C *3 times	3 times	No catastrophics
Reliability Test 2			
Stress Test	Stress Conditions	Stress Duration	Failure Criteria
Room Temperature Operating Life	25°C, I _F = max DC (Note 2)	1000 hours	No catastrophics
High Temperature and high Humidity Life	85°C / 85%RH, I _F = 5 mA	1000 hours	No catastrophics
Low Temperature Storage	-40°C	1000 hours	No catastrophics
High Temperature and high Humidity Storage	85°C / 85%RH	1000 hours	No catastrophics
Ambient Temperature Life	25°C, I _F = 20 mA	1000 hours	No catastrophics
Temperature Cycle	-40°C/100°C ,30 min dwell <15min transfer	200 cycles	No catastrophics
Thermal Shock	-40 / 100°C, 15 min dwell <10 sec transfer	200 cycles	No catastrophics

Notes:

1. Reliability test 2 is performed after reliability test 1
2. Depending on the maximum derating curve.
3. Failure Criteria:
 - Electrical failures
 - V_F Shift >=10%
 - Luminous Intensity
 - I_V Decay >= 35%

Color Spectrum and Radiation Pattern

Emission Angle Characteristics

< Table 7 Emission angle Characteristics at $I_F=20\text{mA}/\text{chip}$ and $T_a=25^\circ\text{C}$ for PLCC 5050 series

>

Part Name	Color	$2\theta_{1/2}$ (Typ.) Lambertian	Unit
ET-5050RTB-311W	-	120	Deg.

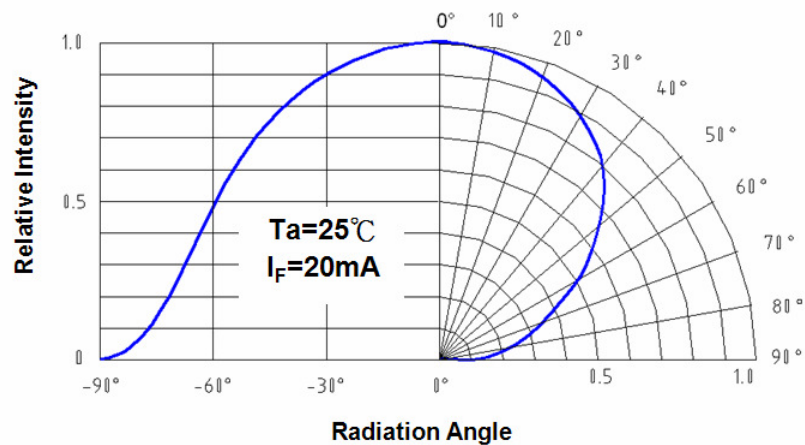

<Figure 3 Beam pattern diagram for PLCC 5050 series >

Color Temperature or Dominant Wavelength Characteristics $T_a=25^\circ\text{C}$

< Table 8 Dominant Wavelength or Peak wavelength at $I_F=20\text{mA}/\text{chip}$ and $T_a=25^\circ\text{C}$ for PLCC 5050 series >

Part Name	Color	V_F			Unit
		Min.	Typ.	Max.	
ET-5050RTB-311W	Red	620	625	630	nm
	True Green	520	525	535	nm
	Blue	465	470	475	nm

Note:

1. Wavelength is measured with an accuracy of $\pm 1\text{nm}$

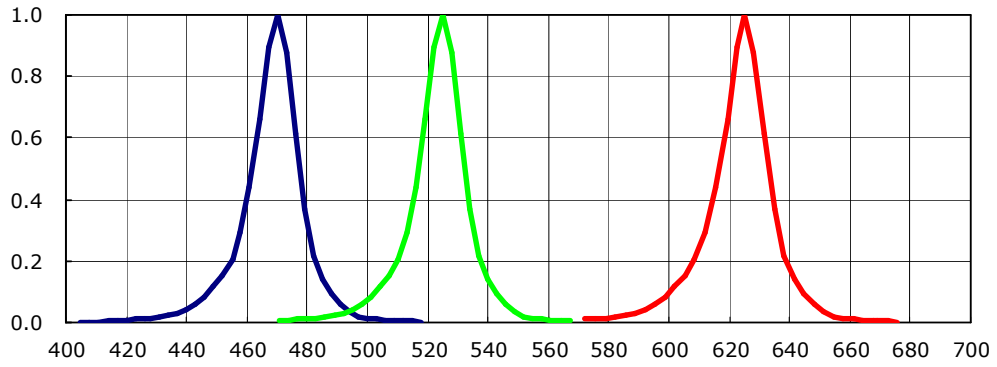

< Figure 4 Wavelength & relative intensity for PLCC 5050 series >

Optical & Electrical Characteristics

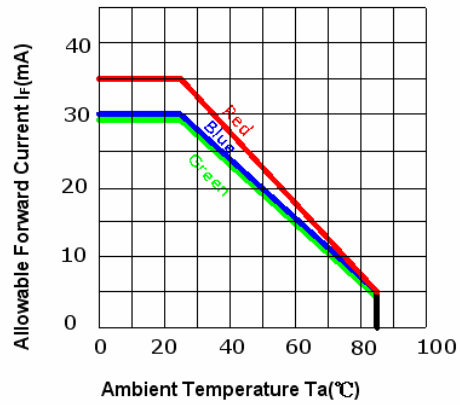

< Figure 5 Ambient temperature & forward current for PLCC 5050 series >

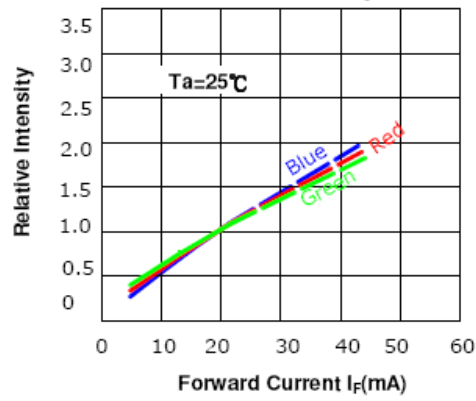

< Figure 6 Forward current & relative intensity for PLCC 5050 series >

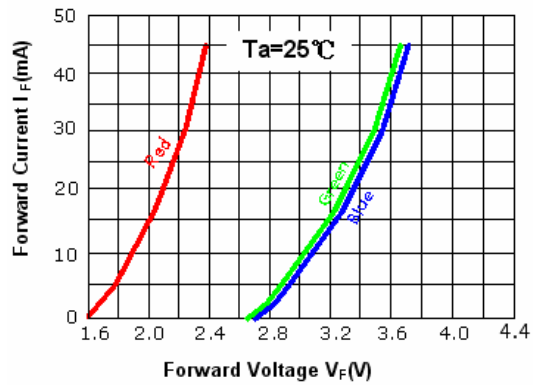

< Figure 7 Forward voltage & forward current for PLCC 5050 series >

Product Soldering Instructions

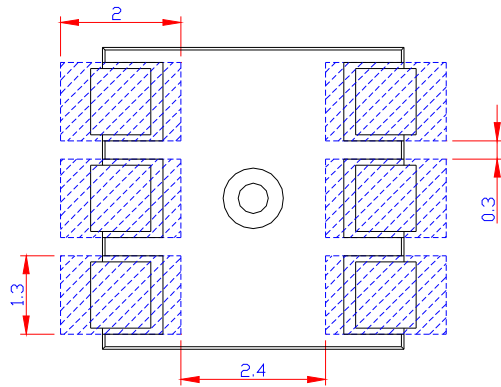

<Figure 8.Pad Dimension >

Note:

1. All dimensions are measured in mm.

The following reflow soldering profiles are provided for reference. It is recommended that users follow the recommended soldering profile provided by the manufacturer of the solder paste used

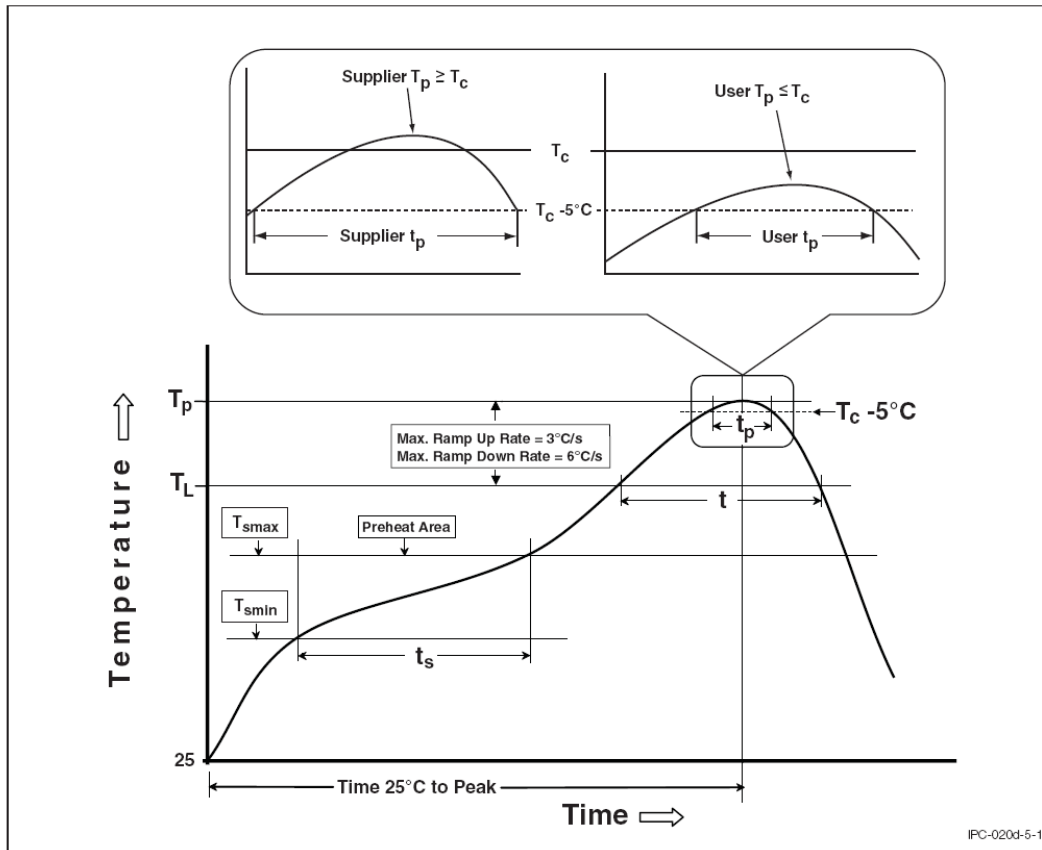

< Figure 9 Time-temperature of JEDEC J-STD-020D >

Table of Classification Reflow Profiles

< Table 9 Reflow profiles >

Profile Feature	Sn-Pb Eutectic Assembly	Pb-Free Assembly
Preheat & Soak Temperature min (Tsmmin) Temperature max (Tsmmax) Time (Tsmmin to Tsmmax) (ts)	100 °C 150 °C 60-120 seconds	150 °C 200 °C 60-120 seconds
Average ramp-up rate (Tsmmax to Tp)	3 °C/second max.	3 °C/second max.
Liquidous temperature (TL) Time at liquidous (tL)	183 °C 60-150 seconds	217 °C 60-150 seconds
Peak package body temperature (Tp)*	230 °C ~235 °C *	255 °C ~260 °C *
Classification temperature (Tc)	235 °C	260 °C
Time (tp)** within 5 °C of the specified classification temperature (Tc)	20** seconds	30** seconds
Average ramp-down rate (Tp to Tsmmax)	6 °C/second max.	6 °C/second max.
Time 25 °C to peak temperature	6 minutes max.	8 minutes max.

* Tolerance for peak profile temperature (Tp) is defined as a supplier minimum and a user maximum.

** Tolerance for time at peak profile temperature (tp) is defined as a supplier minimum and a user maximum.

Product Packaging Information

Taping Reel

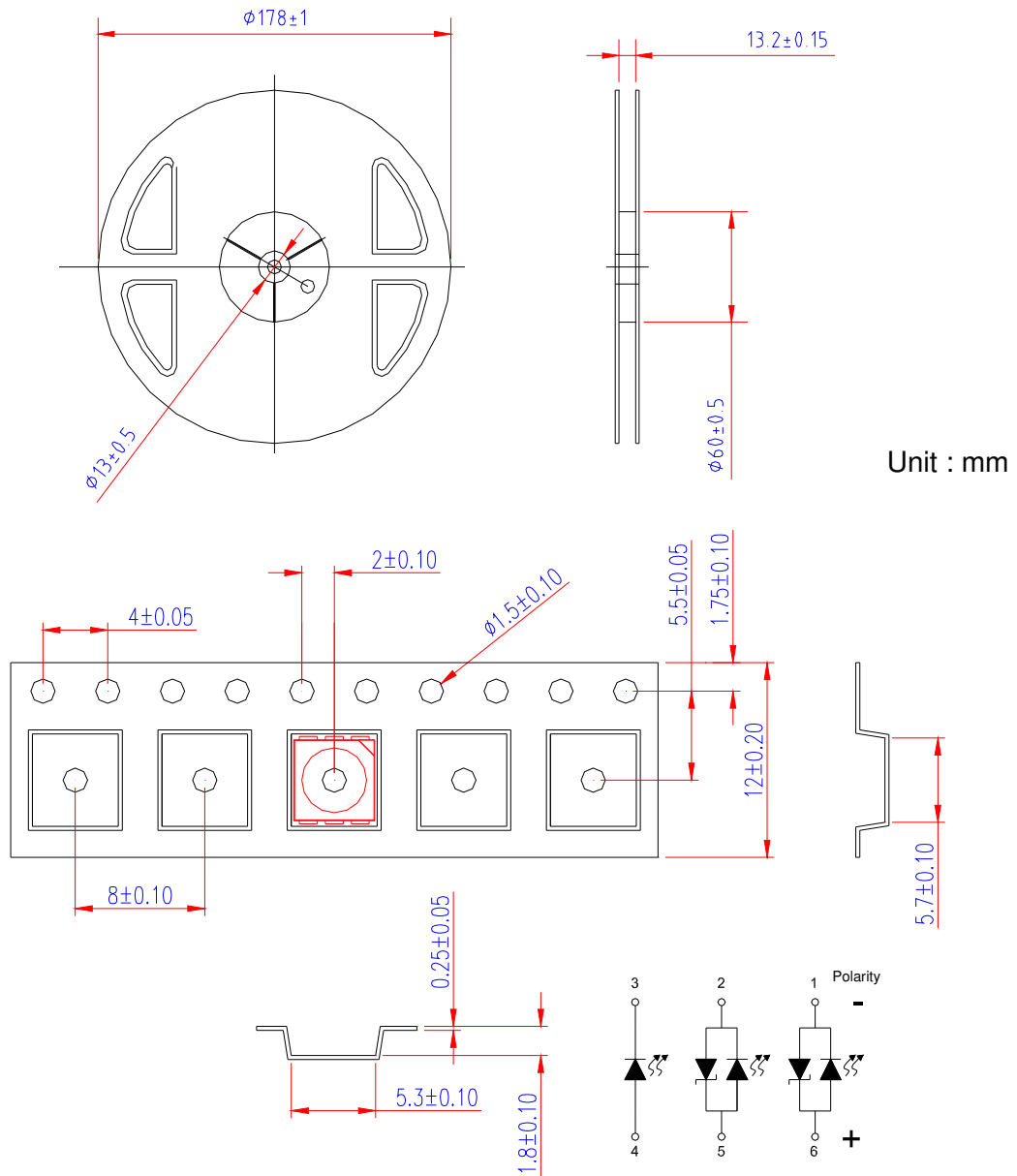

< Figure 10 Taping reel dimensions >

Packaging

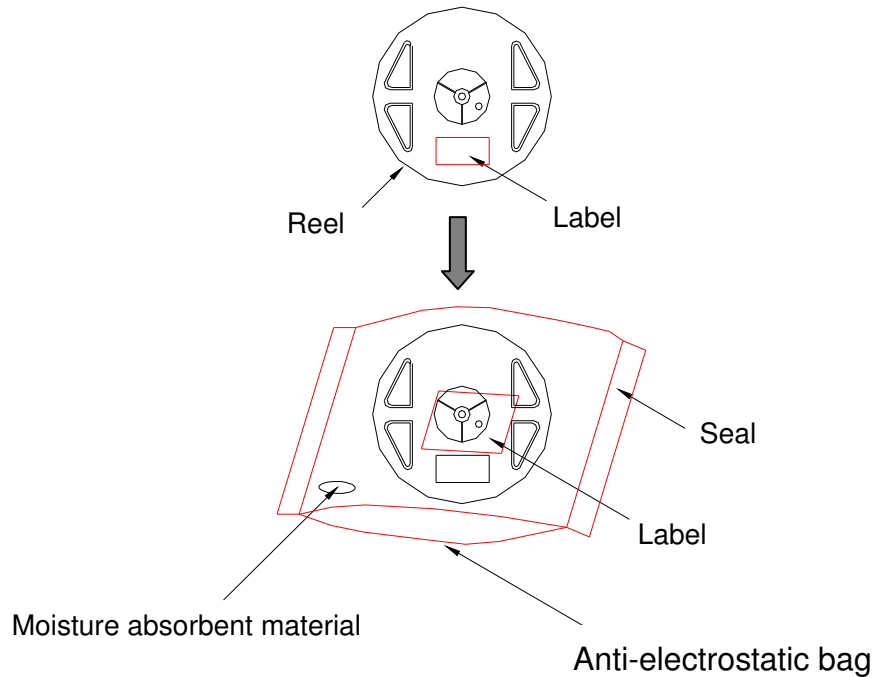

< Figure 11 Packaging diagram >

Package Label

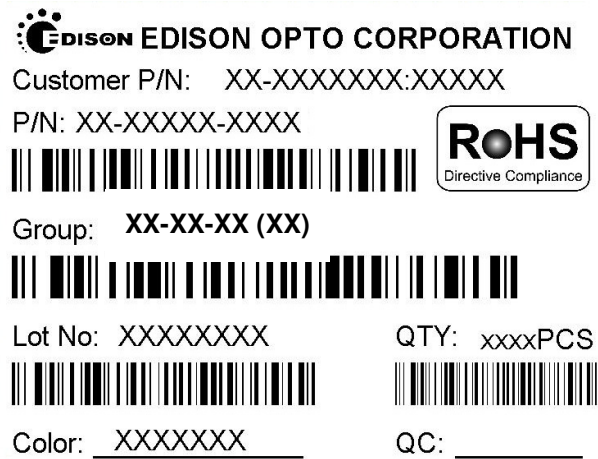

< Figure 12 Package label >

< Table 10 Package dimensions and quantity >

Item	Quantity	Total	Dimensions(mm)
Reel	1,000pcs	1,000pcs	Diameter=178
Inner box	4 reels	4,000pcs	240*235*67
Outer box	5 inner boxes	20,000pcs	353*254*256

Precaution for Use

Storage

1.1 Before opening the package

The LEDs should be kept at $<40^{\circ}\text{C}$ & $<90\%RH$. The LEDs should be used within a year. When storing the LEDs, anti-electrostatic package with moisture absorbent material (silica gel) is recommended.

1.2 After opening the package

The LEDs should be kept at $\leq 30^{\circ}\text{C}$ & $\leq 60\%RH$. The LEDs should be soldered within 168 hours (7days) after opening the moisture proof and anti-electrostatic package.

If unused LEDs remain, they should be stored in moisture proof and anti-electric packages, such as sealed containers with moisture proof package within absorbent material (silica gel) and anti-electrostatic bag. It is also recommended to return the unused LEDs to the original moisture proof and anti-electrostatic package and to seal the moisture proof and anti-electrostatic package again. If the moisture absorbent material (silica gel) vapors or expires the expiration date, baking treatment should be performed by using the following conditions : 60°C for 20 hours.

The LEDs electrode and leadframe comprise a silver plated copper alloy. The silver surface may be affected by environments. Please avoid conditions which may cause the LEDs being corroded or discolored. The corrosion or discoloration might lower solderability or affect optical characteristics.

Please avoid rapid transition in ambient temperature, especially in high humidity environments where condensation can occur.

Static electricity

The products are sensitive to static electricity and highly taken care when handling them.

Static electricity or surge voltage will damage the LEDs. It is recommended to wear an anti-electrostatic wristband or an anti-electrostatic glove when handling the LEDs.

All devices, equipments and machinery must be properly grounded. It is recommended that measures be taken against surge voltage to the equipment that mounts the LEDs.

Note:

All the information published is considered to be reliable. However, EDISON OPTO does not assume any liability arising out of the application or use of any product described herein.

EDISON OPTO reserves the right to make changes at any time without notice to any products in order to improve reliability, function or design.

EDISON OPTO products are not authorized for use as critical components in life support devices or systems without the express written approval from the managing director of EDISON OPTO.

Forward Voltage Rank

< Table 11 Forward voltage rank at $I_F=20\text{mA}/\text{chip}$ and $T_a=25^\circ\text{C}$ >

Color of Emission	Bin	Min	Max	Unit
Red	VD	1.8	2.1	V
	VE	2.1	2.4	
	VF	2.4	2.8	
True Green Blue	VG	2.8	3.1	
	VH	3.1	3.4	
	VI	3.4	3.7	

Note:

1. Forward voltage measurement allowance is $\pm 0.1\text{V}$.

Luminous Intensity Rank

< Table 12 Luminous intensity rank at $I_F=20\text{mA}/\text{chip}$ and $T_a=25^\circ\text{C}$ >

Color of Emission	Bin	Min	Max	Unit
Red	G	300	350	mcd
	H	350	400	
	I	400	500	
	J	500	600	
	K	600	700	
True Green	L	700	850	mcd
	M	850	1,000	
	N	1,000	1,150	
	O	1,150	1,300	
	P	1,300	1,450	
Blue	D	175	200	mcd
	E	200	250	
	F	250	300	
	G	300	350	
	H	350	400	

Note:

1. Luminous Intensity Measurement Allowance is $\pm 10\%$.

Dominant Wavelength Rank

< Table 13 Dominant Wavelength rank at $I_F=20\text{mA}/\text{chip}$ and $T_a=25^\circ\text{C}$ >

Color of Emission	Bin	Min	Max	Unit
Red	Full	620	630	nm
True Green	W	520	525	nm
	X	525	530	
	Y	530	535	
Blue	X	465	470	nm
	Y	470	475	

Note:

1. Dominant wavelength is measured with an accuracy of $\pm 1\text{nm}$